

Walther P99 On-Line Manual



The Safety Systems

To Fire this Gun, Pull the Trigger!

There is no manual "on/off" safety mechanism.

There is nothing to block the trigger from being pulled IF YOU PUT YOUR FINGER ON THE TRIGGER AND PULL IT.

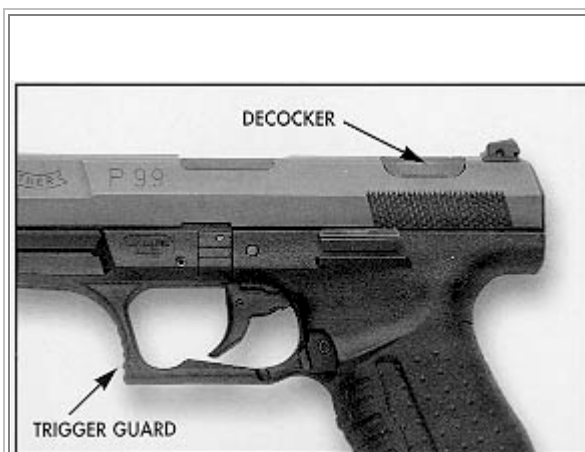

TRIGGER GUARD: This keeps you from inadvertently placing your finger on the trigger. You must put your finger inside the trigger guard before you can come in contact with the trigger. It also helps guard against other objects bumping the trigger and accidentally fired the pistol. **Do not put your finger inside the trigger guard unless you actually intend to fire the gun, especially when you are loading the first round into the chamber.**

DECOCKER: This lets you decock the striker if you are not going to shoot the pistol immediately after loading it.

WARNING: This pistol has no manually operated "ON SAFE" / "OFF SAFE" safety lever or button to prevent pulling the trigger. Pulling the trigger fires the pistol if the chamber is loaded.

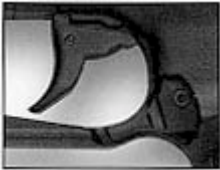
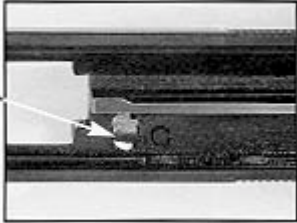
	<p>TRIGGER SAFETY: This prevents the trigger from traveling rearward unless the trigger is first pivoted by pressure on the lower part of the trigger.</p>	<p>STRIKER BLOCK SAFETY: This block prevents the striker from moving forward unless the trigger is pulled.</p>	
---	---	---	---

WARNING: NEVER RELY COMPLETELY ON ANY MECHANICAL SAFETY.

It is NOT a substitute for safe gun handling. A safety is a mechanical device, and like any mechanical device it could fail at the worst possible moment. Never disobey the rules of safe gun handling, thinking any safety device or combination of safeties will protect you or those around you from injury or death. Firearm safety is up to you.

Two-Way Loaded Chamber Indicator

If the chamber is loaded, the rear of the extractor is recessed into the slide.

In the Light

There is a red dot on the right of the slide, which is visible when the chamber is loaded with a cartridge. It is toward the rear

of the extractor slot. When that red dot is exposed, you know the chamber is loaded and the pistol is ready to fire. Also, you can see that the rear of the extractor is recessed into the slide.



In the Dark

You can feel the extractor slot above the serrated finger grooves on the right side of the slide. If you can feel that it is recessed, the chamber is loaded and the pistol is ready to fire. If it feels flush with the slide, there is no cartridge in the chamber. **Before you try to use this method, practice it under safe conditions with the chamber loaded and unloaded, so you know what it feels like when loaded or unloaded.**

WARNING: DO NOT COUNT ON SEEING THE RED DOT.

Cleaning solvents or wear may darken or remove the red color, or powder residue or dirt may cover it up. If you do not see the red dot, don't assume the chamber is empty. Look at the extractor or feel it with your hand so you know if the chamber is loaded, or open the slide and check the chamber.

Cocking Indicator

When the striker is cocked, it sticks out the back of the pistol. You will find it where the retaining plate is recessed in the center of the rear of the slide.

You can see it and feel it. It has a red dot in the end.

When you put your finger on the retaining plate you can tell if the striker is cocked or not. If you can feel it sticking out, the striker is cocked and the trigger is in single action mode. If it feels smooth, it is not cocked, and the trigger is in double action mode. **Before you try to use this method, practice it under safe conditions with the chamber unloaded, so you know what it feels like when cocked or decocked.**

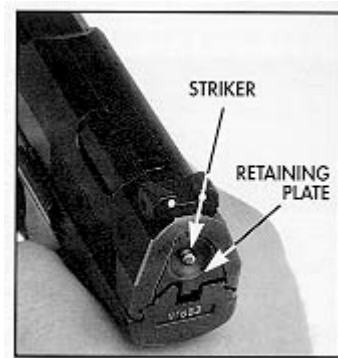

WARNING: DO NOT COUNT ON SEEING THE RED DOT.

Cleaning solvents or wear may darken or remove the red color, or powder residue or dirt may cover it up. If you do not see the red dot, don't assume the striker is decocked. Look at the striker or feel it with your finger so you know if the striker is cocked.

WARNING: THE COCKING INDICATOR IS NOT A LOADED CHAMBER INDICATOR. Some models have a Loaded Chamber Indicator in a similar position to the Model P 99's Cocking Indicator. **THE P 99's LOADED CHAMBER INDICATOR IS ON THE RIGHT SIDE OF THE SLIDE.**

Loading

WARNING: READ THE REST OF THIS MANUAL BEFORE YOU LOAD, so you understand how the pistol works, and you know you can handle it safely.

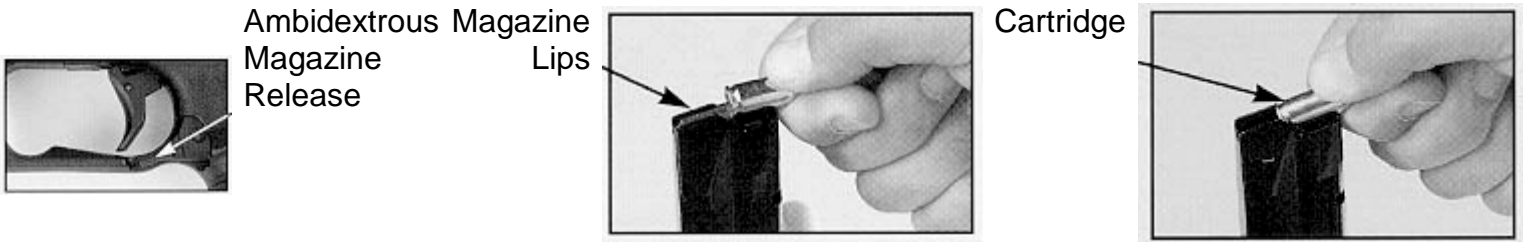

The proper ammunition for these pistols is either 9mm or .40 S&W, depending on what is marked on your particular pistol. There are many kinds of 9mm ammunition. The 9mm ammo for this pistol is 9x19mm, also called 9mm Luger, 9mm Parabellum or 9mm Para.

To take out the magazine, push the magazine release down and the magazine will slide out of the pistol.

Both models hold 10 rounds in the magazine. Load each cartridge into the magazine with two motions: first DOWN to compress the magazine spring, then REARWARD to slide the cartridge under the magazine lips. To empty the magazine, take it out of the pistol and push each cartridge forward until it comes free of the magazine lips. CAUTION: Bent or damaged magazine lips will cause malfunctioning of the pistol. Do not drop the magazine. Do not use force when loading or unloading the magazine.

WARNING: Keep your fingers out of the trigger guard and off the trigger when loading.

Loading continued

Ammunition Warning:

DO NOT USE HANDLOADS, RELOADED OR REMANUFACTURED AMMUNITION, OR HOME LOADS. Use only original, high quality, factory manufactured ammunition in good condition. Because of the dangers of poor or nonexistent quality control among some companies and people who make reloaded ammunition, and the well known problem of dangerous overloads and underloads (squib loads) which sometimes happen, only good quality factory ammunition should be used. If you prepare your handloads be careful, and do not exceed recommended pressures in line with those generated by standard factory loads (not +P) as manufactured by Remington, Winchester, Federal, Hornady, PMC or other reputable companies.

To Load with the Slide Open

Push the magazine firmly into the magazine well, in the butt of the pistol, until the magazine catch snaps it in place. Hold the pistol securely and point it in a safe direction. Push down on the slide stop. The slide will snap forward, loading the chamber as it closes. **WARNING: THE PISTOL IS NOW LOADED AND READY TO FIRE! THE SLIDE CLOSSES WITH GREAT FORCE. KEEP YOUR HANDS AND FINGERS CLEAR, OR THEY MAY BE SEVERELY PINCHED OR CUT.** Do not hold onto the slide as it closes, or "help" it forward, as this may cause a jam, failure to feed or failure to extract.

If you are not going to fire the pistol right away, immediately push the decocker to decock the striker, placing the pistol in double action mode, for increased safety.



Loading continued

To Load with the Slide Closed

Push the magazine firmly into the magazine well, in the butt of the pistol, until the magazine catch snaps it in place. You must push hard because the slide is closed and you are squeezing the cartridges in the magazine up against the bottom of the slide, so you must compress the spring inside the magazine. **CAUTION:** If you do not latch the magazine securely, the pistol will not reload itself, and the magazine may fall out. Hold the pistol securely by the grip and point it in a safe direction. Grasp the grooves of the slide firmly with your fingers and thumb and pull the slide all the way back. Then let it go. It will load the chamber as it closes. **WARNING: THE PISTOL IS NOW LOADED AND READY TO FIRE!** Do not hold onto the slide as it closes, or "help" it forward, as this may cause a jam, failure to feed or failure to extract.



If you are not going to fire the pistol right away, immediately push the decocker to decock the striker, placing the pistol in double action mode, for increased safety.

Decocking the Striker

When the striker is cocked, the trigger is in single action mode. To return the trigger to double action mode, press down on the decocker. This will allow the striker to go forward without firing the cartridge in the chamber.

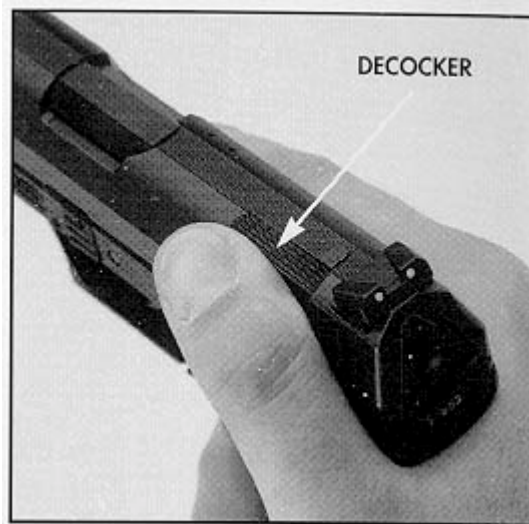

WARNING: Keep your finger off the trigger and out of the trigger guard when decocking the pistol.

4 RULES FOR SAFE GUN HANDLING

1. **Always keep the gun pointed in a safe direction.**
2. **Always keep your finger off the trigger until ready to shoot.**
3. **Always keep the gun unloaded until ready to use.**
4. **Don't drop the gun.**

Firing the Pistol

There are three ways to fire this pistol - double action mode (trigger forward), single action mode (trigger forward) and single action mode (trigger rearward).



TRIGGER IN FORWARD POSITION FOR SINGLE AND DOUBLE ACTION FIRING.

Double Action Firing

The trigger is in the forward position when firing in double action mode. For a quick first shot when fine accuracy is not the most important concern, point the pistol at the target and take aim. TO FIRE: pull the trigger all the way through the full length of its travel. This cocks the striker and fires the pistol all in one motion.

Single Action Firing - Trigger Forward

If the striker is decocked, but you wish to fire the first shot single action, point the pistol in a safe direction, pull the slide back about 3/8 inch and let it go. This cocks the striker without ejecting the round in the chamber. When you have loaded the first round into the chamber, or if you have decocked the striker and then cocked it again without firing the pistol, the trigger is forward, in the same position as double action mode, BUT THE TRIGGER PULL WILL BE MUCH LIGHTER. TO FIRE: carefully take up the slack until the trigger clicks into the single action position, and then fire the pistol in single action mode.

WARNING: The single action trigger pull is much lighter and shorter than the double action pull. Be sure you look at the cocking indicator in the rear of the slide to see if you are in single action or double action BEFORE you put your finger on the trigger.

Firing the Pistol continued

Single Action Firing - Trigger Rearward

After you fire the first shot the striker is cocked and all shots are single action. In single action mode the trigger is much further back in the trigger guard and the **TRIGGER PULL IS MUCH SHORTER AND LIGHTER.**

TO FIRE: squeeze the trigger all the way back.

TO FIRE:

- Be sure you have a safe backstop.
- Aim the pistol at the target.
- **THINK!** What will you **HIT** if you **MISS** the target?
- Squeeze the trigger to fire the pistol. This is a semiautomatic pistol, so it will fire every time you squeeze the trigger until it is empty.



Trigger in Rearward Position

WARNING: If a shot sounds unusual...not loud enough or too loud... or if the recoil feels different, **CEASE FIRE! Unload the pistol completely and check the**

barrel. It could be plugged by a bullet from a defective cartridge. **DO NOT FIRE AGAIN** until the obstructed barrel is unblocked. If you do fire again the gun might blow up and kill or injure you or others, or the gun could be damaged.

To Clear a Jam: Keep the pistol pointed in a safe direction. Take out the magazine. Pull the slide open and clear the jammed cartridge.

WARNING: Do not let live ammunition fall onto a hard surface, sharp edge or pointed object. It could go off.

Reloading

You may reload during firing before the pistol is empty.

With Chamber Loaded

WARNING: The pistol will still fire with the magazine removed.

Keep your finger out of the trigger guard and off the trigger, and keep the pistol pointed in a safe direction.

Press the magazine release and take the magazine out of the pistol. Put a loaded magazine into the pistol and push hard until the magazine catch locks in place. You must push hard because the slide is closed, so you are squeezing the cartridges in the magazine down against the magazine spring. **CAUTION: If you do not latch the magazine securely, the pistol will not reload itself after the first shot, and the magazine may fall out.**

With Chamber Empty

When you fire the last shot in the pistol, the slide will lock open. To reload, take out the empty magazine, push a loaded magazine firmly into the pistol and close the slide as in the **LOADING** section.

Unloading

WARNING: After you take out the magazine the pistol may still be loaded and ready to fire.

Just taking the magazine out...

1. Does not unload the chamber
2. Does not prevent firing a live round loaded in the chamber.

To unload, first decock the striker, then remove the magazine, and then pull the slide all the way back to remove the cartridge in the chamber. Do this over a soft surface so the live cartridge does not fall onto something that could fire it.

Do not fail to unload the chamber by pulling the slide open after the magazine is out, or the pistol may still be loaded and able to fire. Hold the slide open and LOOK in the chamber to be sure it is empty.

WARNING: Watch your hands and the muzzle of the pistol when you handle it. Do not let it point at your fingers or any other part of your body.

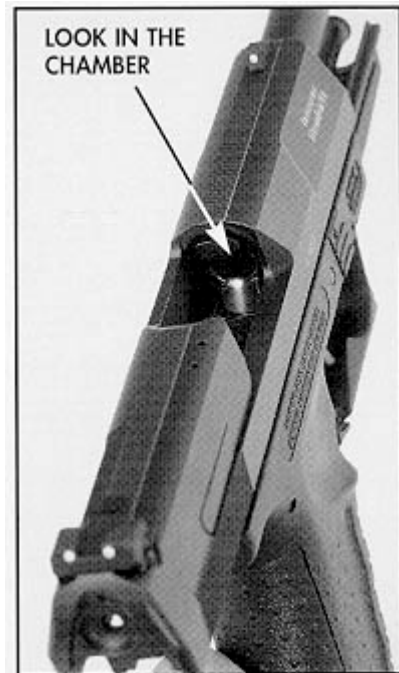

The magazine maybe unloaded by pushing each round forward and out of the magazine by hand. Be careful not to let live ammunition fall onto something hard or sharp that could make it go off.



Disassembly

WARNING: It is possible to disassemble this pistol with a live cartridge loaded in the chamber. **DO NOT DO SO.** Be sure you unload the pistol completely before starting disassembly. Take out the magazine and clear the chamber by pulling open the slide and looking in the chamber to be sure it is empty.

Field stripping takes no tools. Do not pry or hammer on this pistol. First, decock the striker by pushing down on the decocker. With the pistol unloaded, hold the grip with your right hand and put your left index finger and thumb on the takedown catch. With your left hand pull down the takedown catch. When it comes down about 1/8 inch, you can push the slide forward off the frame.

	Takedown Catch	Holding the slide assembly upside down, push the recoil spring unit slightly forward and lift it up.		The barrel can now be lifted from the slide.	
--	----------------	--	--	--	--

REMOVING THE STRIKER UNIT:

There is generally no need to remove the striker unit. If you are detail cleaning the pistol, you may want to take out the striker unit and clean it too. However, do not try to disassemble the striker unit itself.

To take the striker unit out of the slide, hold the slide so you can press and hold the decocker down. Then push in the retaining lug with a small screwdriver or flat

Decocker

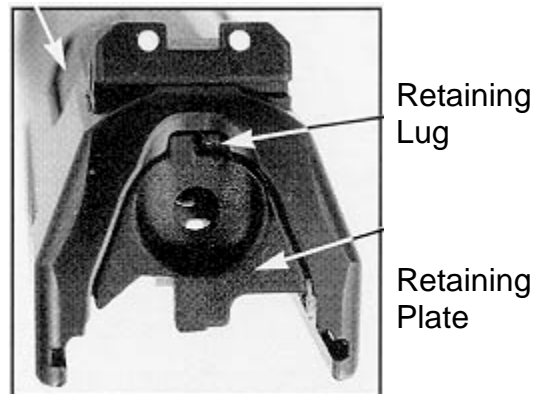

nosed punch and slide the retaining plate down out of the slide. Slide out the striker assembly and ease the decocker up off the slide. If you do not hold the decocker down it will fly off the slide, and you might lose or damage it. The decocker return spring is press-fitted into the hole in the bottom of the decocker. Do not try to take it out, or you might bend or stretch this small spring, and you might lose it. **NO FURTHER DISASSEMBLY OF THE PISTOL IS RECOMMENDED.**

MAGAZINE DISASSEMBLY: BEFORE YOU START TAKE A GOOD LOOK at the magazine, follower, and floorplate assembly so you can put them back together again in proper relationship.

In your accessory kit there is a magazine disassembly pin. Insert the narrow end of the pin into the hole in the bottom of the magazine. Push in against the pressure of the magazine spring and slide the floorplate assembly (the bottom part of the magazine) forward about 1/4 inch. Take out the disassembly pin and set it aside. Carefully controlling the magazine spring with your finger or thumb, slide the floorplate assembly off and remove the spring, floorplate and follower from the magazine. To reassemble, you do not need the disassembly pin.

Assembly

REPLACING THE STRIKER UNIT: Put the decocker in its slot, press it all the way down and hold it there. Slide the striker unit into the striker tunnel and push it all the way in. Slide the retaining plate into its slot. When you push it all the way up you will hear it snap into position. If you have done it correctly the decocker will be retained in the slide by the striker unit.

WARNING: Before you start, check the barrel to be sure there is no cartridge in the chamber. Put the barrel in the slide and move it into its locked position. Note that the recoil spring unit has one wide black end and one narrow black end. Fit the narrow end against the forward part of the slide and compress the spring slightly. Fit the wide end against the barrel lug. There are two steps on the lug. It goes against the front step, which has the tapered ramp leading up to it.



Carefully line up the rails on both sides of the frame with the grooves in the slide. Fit the two units together and pull the slide back until the takedown catch clicks up into place.

Reassembly is complete. Before you load, slide the slide back and forth to check for proper assembly and proper function of the pistol.

Care and Cleaning

WARNING: How often have you heard this excuse for gun accidents? " I was cleaning it and I didn't know it was loaded!" **UNLOAD THE PISTOL BEFORE YOU START TO CLEAN IT.**

Take out the magazine, open the slide and check the chamber to be sure the pistol is unloaded.

Disassemble the pistol as shown in the **DISASSEMBLY** section.

A good quality modern gun solvent, such as Hoppe's No. 9 Nitro Powder Solvent and gun oil or light household oil are all you need to care for this pistol. Wipe all surfaces with a soft cloth or cleaning patch moistened with solvent. Do not try to clean the gun with oil, as oil will not dissolve the residue left by smokeless powder cartridges. Using a round bristle brush, brush the barrel bore and chamber with solvent. Also use the brush on any buildup of power residue, dirt or fouling on the frame, slide, spring and magazine. Then wipe everything off with a dry rag or patches.

You must use a light oil after cleaning, to lubricate the pistol and protect the steel from rust, but use it sparingly. A light coating of oil is all that is needed. Too much oil can eventually become gummy and sticky, or attract dust and debris, and prevent smooth reliable functioning.

From time to time, check the magazine for dirt, sand or debris, and make sure the parts slide freely up and down. Oil it very sparingly.

Reassemble the pistol as shown in the **ASSEMBLY** section. Fingerprints can cause rust. Wipe them off before putting the pistol away.

Sights

Elevation

To adjust the strike of the bullet higher or lower, remove the front sight and replace it with one of the three extra front sights included in your accessory kit. Be sure the pistol is unloaded and remove the slide. Take the recoil spring unit and barrel out. Insert the very thin Allen wrench from your accessory kit into the tiny Allen screw in the bottom of the sight. Carefully unscrew it. Because of its size, you must be very careful not to lose the screw or strip it. With the screw out, put a 1/8 inch flat nosed punch against the bottom of the sight and tap it out.

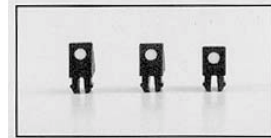
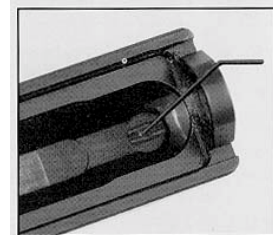

Line up the new sight carefully and gently tap it into place. Put in the tiny Allen screw to secure the sight. Make it snug, but do not over tighten it.

To move the point of impact UP install a LOWER front sight. To move the point of impact DOWN install a TALLER front sight.

Windage

To adjust the strike of the bullet left or right on the target, turn the screw in the right side of the rear sight. One click (1/4 turn) moves the bullet a little over 1/16 inch at 25 yards.

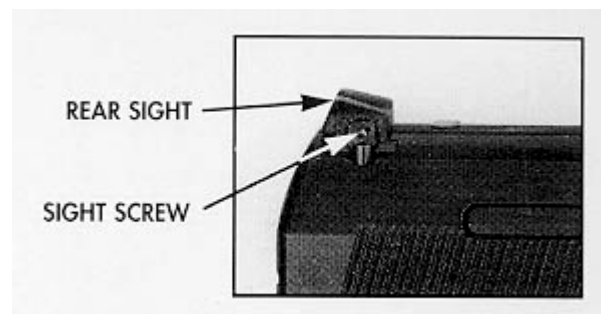

Turn the sight screw **CLOCKWISE** to move the point of impact **LEFT**. Turn the right screw **COUNTER-CLOCKWISE** to move the point of

impact RIGHT.

Light Rails

Square grooves are provided on both sides of the frame in front of the trigger guard. These are parallel to the bore. They are a universal accessory mounting point which maybe used to install a flashlight, external electronic aiming device or other accessory.



Light Rail

Check with the various sight and mount companies for mounts adapted to these light rails.

Customizing the Grip

The Walther P99 pistol has three interchangeable cushioned backstraps for the grip. If the one presently on the pistol does not fit your hand comfortably, you can install one of a different size and shape.



Using a round flat-nosed punch of the proper size, gently tap out the roll pin in the lower part of the grip. You can take the backstrap out with your fingers.

When you put in the new backstrap, first fit the small tab at the top into the pistol grip, then push the lower end into the slot. Carefully put the roll pin back in place and tap it into the grip until it is centered.

Specifications

Caliber	9mm or .40 S&W
Magazine Capacity	10 shots (plus 1 in the chamber = 11) *
Length	7.09" (180mm)
Height	5.31" (135mm)
Width	1.14" (29mm)
Barrel Length	4" (102mm)
Rifling	6 grooves, right hand twist
Sight radius	6.26" (159mm)
Weight with Magazine Empty	24.7 oz. (700g)

* 16 shots for Law Enforcement